

SK45MAHT12SCp

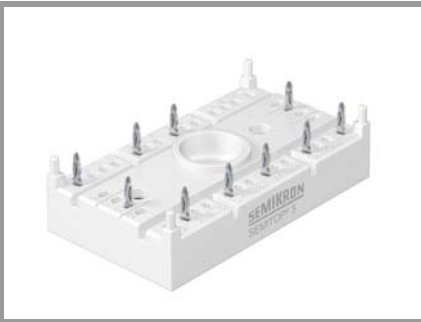

SEMITOP® 3 Press-Fit

SiC MOSFET Module

SK45MAHT12SCp

Features

- One screw mounting module
- Fully compatible with other SEMITOP® Press-Fit types
- Improved thermal performance by aluminum oxide substrate
- Three phase inverter topology with split output
- Ultra Low inductance design
- SiC 1200V Planar MOSFET
- SiC 1200V Schottky FWD
- Extremely fast switching
- UL recognized, file no. E63532

Typical Applications*

- Solar inverter
- UPS
- Power Supply

Remarks

Diode1 = SiC Schottky FWD

| Absolute Maximum Ratings | | | | |
|------------------------------|---|----------------------|------|---|
| Symbol | Conditions | Values | Unit | |
| MOSFET 1 | | | | |
| V_{DSS} | | 1200 | V | |
| I_D | $T_j = 175\text{ °C}$ | $T_s = 25\text{ °C}$ | 39 | A |
| | | $T_s = 70\text{ °C}$ | 32 | A |
| I_{DM} | $PW \leq 10\mu s$, duty cycle $\leq 1\%$ | 160 | A | |
| I_{DRM} | | 113 | A | |
| V_{GS} | | -6 ... 22 | V | |
| T_j | | -40 ... 175 | °C | |
| Integrated body diode | | | | |
| I_{FM} | $PW \leq 10\mu s$, duty cycle $\leq 1\%$ | 160 | A | |
| I_{FRM} | | 113 | A | |

| Absolute Maximum Ratings | | | | |
|--------------------------|-----------------------|-----------------------|------|---|
| Symbol | Conditions | Values | Unit | |
| Diode 1 | | | | |
| V_{RRM} | $T_j = 25\text{ °C}$ | 1200 | V | |
| I_F | $T_j = 175\text{ °C}$ | $T_s = 25\text{ °C}$ | 56 | A |
| | | $T_s = 70\text{ °C}$ | 45 | A |
| I_{Fnom} | | 50 | A | |
| I_{FRM} | | 113 | A | |
| I_{FSM} | 8.3 ms sin 180° | $T_j = 25\text{ °C}$ | 207 | A |
| | | $T_j = 150\text{ °C}$ | 156 | A |
| T_j | | -40 ... 175 | °C | |

| Absolute Maximum Ratings | | | |
|--------------------------|---|-------------|------|
| Symbol | Conditions | Values | Unit |
| Module | | | |
| $I_{t(RMS)}$ | $T_{terminal} = 100\text{ °C}$, $T_s = 60\text{ °C}$, per pin | 40 | A |
| T_{stg} | | -40 ... 125 | °C |
| V_{isol} | AC, sinusoidal, t = 1 min | 2500 | V |

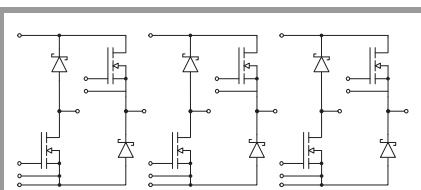

MAHT

SK45MAHT12SCp

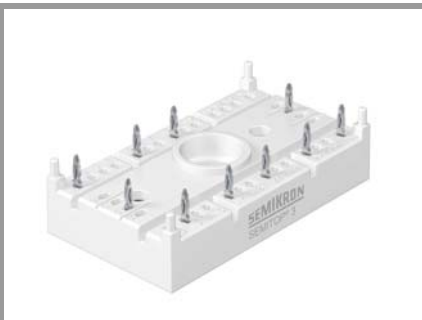

SEMIPRESS® 3 Press-Fit

SiC MOSFET Module

SK45MAHT12SCp

Features

- One screw mounting module
- Fully compatible with other SEMIPRESS® Press-Fit types
- Improved thermal performance by aluminum oxide substrate
- Three phase inverter topology with split output
- Ultra Low inductance design
- SiC 1200V Planar MOSFET
- SiC 1200V Schottky FWD
- Extremely fast switching
- UL recognized, file no. E63532

Typical Applications*

- Solar inverter
- UPS
- Power Supply

Remarks

Diode1 = SiC Schottky FWD

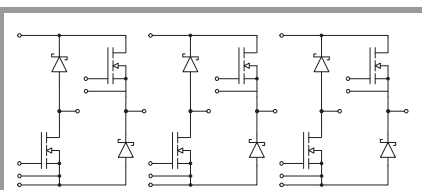

MAHT

| Characteristics | | | | | |
|------------------------------|--|-----------------------|------|------|------|
| Symbol | Conditions | min. | typ. | max. | Unit |
| MOSFET 1 | | | | | |
| $V_{(BR)DSS}$ | $V_{GS} = 0\text{ V}, I_D = 1\text{ mA}, T_j = 25\text{ °C}$ | 1200 | | | V |
| $V_{GS(th)}$ | $V_{DS} = V_{GS}, I_D = 8.9\text{ mA}, T_j = 25\text{ °C}$ | 1.6 | | 4 | V |
| I_{DSS} | $V_{GS} = 0\text{ V}, V_{DS} = 1200\text{ V}, T_j = 25\text{ °C}$ | | | 1 | mA |
| I_{GSS} | $V_{DS} = 0\text{ V}, V_{GS} = 22\text{ V}, T_j = 25\text{ °C}$ | | | 100 | nA |
| $R_{DS(on)}$ | $V_{GS} = 18\text{ V}$ | | 45 | 56 | mΩ |
| | $I_D = 22\text{ A}$ | $T_j = 25\text{ °C}$ | | | |
| | | | 76 | 89 | mΩ |
| C_{iss} | $V_{GS} = 0\text{ V}, V_{DS} = 800\text{ V}, f = 1\text{ MHz}$ | | 4310 | | pF |
| C_{oss} | $V_{GS} = 0\text{ V}, V_{DS} = 800\text{ V}, f = 1\text{ MHz}$ | | 137 | | pF |
| C_{rss} | $V_{GS} = 0\text{ V}, V_{DS} = 800\text{ V}, f = 1\text{ MHz}$ | | 19 | | pF |
| R_{Gint} | $T_j = 25\text{ °C}$ | | 4.7 | | Ω |
| Q_G | $V_{DS}=600\text{V}, V_{GS}=-5\text{V}...+20\text{V}, I_D = 45\text{ A}$ | | 215 | | nC |
| $t_{d(on)}$ | $V_{DD} = 600\text{ V}$ | | 12 | | ns |
| | $V_{GS} = 20/-5\text{ V}$ | $T_j = 150\text{ °C}$ | | | |
| | | $T_j = 150\text{ °C}$ | 64 | | ns |
| t_r | $I_D = 45\text{ A}$ | $T_j = 150\text{ °C}$ | 17 | | ns |
| t_f | $R_G = 0.5\text{ Ω}$ | $T_j = 150\text{ °C}$ | 16 | | ns |
| E_{on} | $di/dt_{off} = 2.2\text{ kA}/\mu\text{s}$ | $T_j = 150\text{ °C}$ | 0.16 | | mJ |
| E_{off} | $di/dt_{on} = 3.9\text{ kA}/\mu\text{s}$ | $T_j = 150\text{ °C}$ | 0.37 | | mJ |
| $R_{th(j-s)}$ | per MOSFET | | 1.04 | | K/W |
| Integrated body diode | | | | | |
| $V_F = V_{SD}$ | $I_D = 50\text{ A}$ $V_{GS} = 0\text{ V}$ chipelevel | $T_j = 25\text{ °C}$ | 6.40 | | V |
| | | $T_j = 150\text{ °C}$ | 5.20 | | V |
| $V_{F0} = V_{SD0}$ | chipelevel | $T_j = 25\text{ °C}$ | 3.90 | | V |
| | | $T_j = 150\text{ °C}$ | 3.40 | | V |
| $r_F = r_{SD}$ | chipelevel | $T_j = 25\text{ °C}$ | 50 | | mΩ |
| | | $T_j = 150\text{ °C}$ | 36 | | mΩ |
| t_{rr} | $V_{DD} = 600\text{ V}$ | | - | | ns |
| Q_{rr} | $I_D = 45\text{ A}$ | | - | | μC |
| I_{rr} | | | - | | A |
| E_{rr} | $V_{GS} = -5\text{ V}$ | | - | | mJ |

| Characteristics | | | | | |
|-----------------|--|-----------------------|-------|------|------|
| Symbol | Conditions | min. | typ. | max. | Unit |
| Diode 1 | | | | | |
| V_F | $I_F = 50\text{ A}$ chipelevel | $T_j = 25\text{ °C}$ | 1.40 | 1.60 | V |
| | | $T_j = 150\text{ °C}$ | 1.80 | 2.10 | V |
| V_{F0} | chipelevel | $T_j = 25\text{ °C}$ | 0.95 | 1.05 | V |
| | | $T_j = 150\text{ °C}$ | 0.80 | 0.90 | V |
| r_F | chipelevel | $T_j = 25\text{ °C}$ | 9.0 | 11 | mΩ |
| | | $T_j = 150\text{ °C}$ | 20 | 24 | mΩ |
| C_j | $V_R = 800\text{ V}, f = 1\text{ MHz}, T_j = 25\text{ °C}$ | | 0.210 | | nF |
| Q_c | $V_R = 800\text{ V}, di/dt_{off} = 500\text{ A}/\mu\text{s}, T_j = 25\text{ °C}$ | | 0.17 | | μC |
| $R_{th(j-s)}$ | per Diode | | 1.14 | | K/W |

| Characteristics | | | | | |
|-----------------|-------------|------|------|------|------|
| Symbol | Conditions | min. | typ. | max. | Unit |
| Module | | | | | |
| M_s | to heatsink | 2.25 | | 2.5 | Nm |
| w | weight | | 30 | | g |

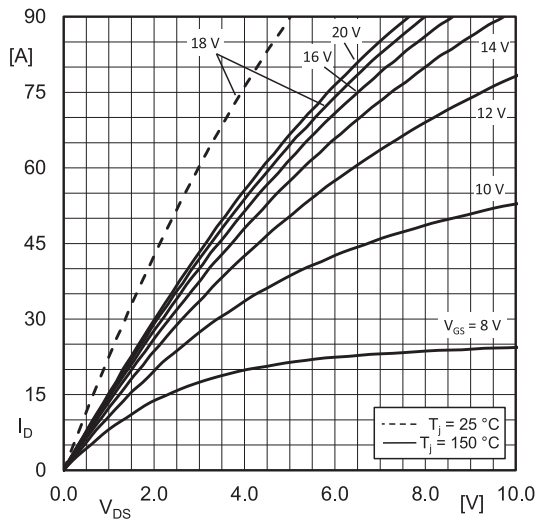

Fig. 1: Typ. MOSFET forward output characteristic, incl. $R_{DD'+SS'}$

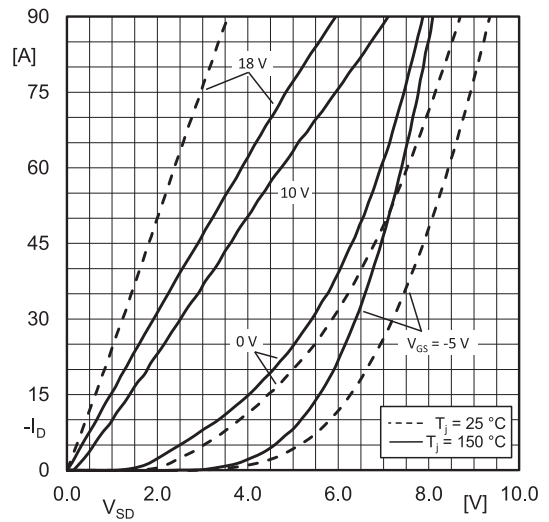

Fig. 2: Typ. MOSFET reverse output characteristic, incl. $R_{DD'+SS'}$

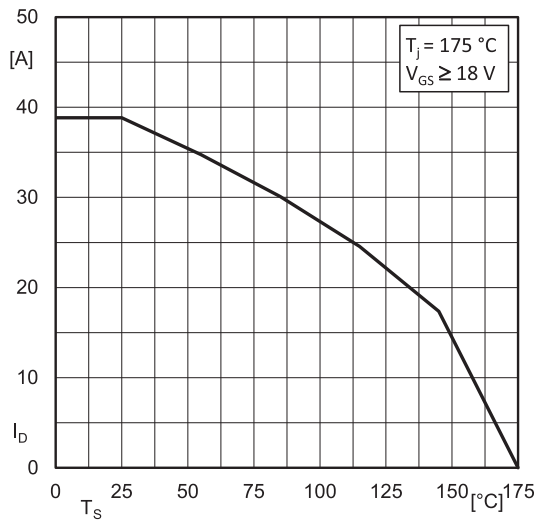

Fig. 3: Rated current vs. temperature $I_D = f(T_S)$

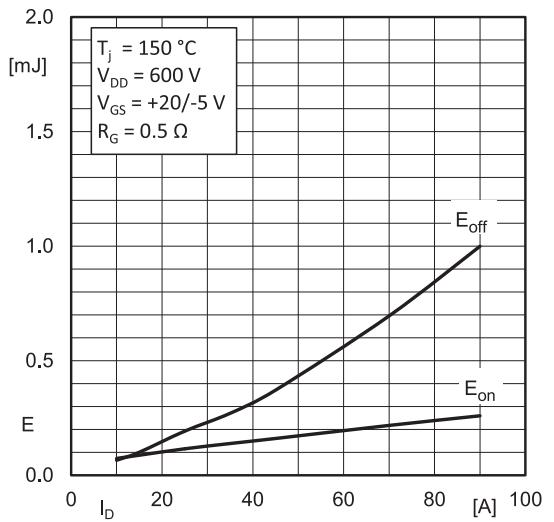

Fig. 4: Typ. turn-on/-off energy $E = f(I_D)$

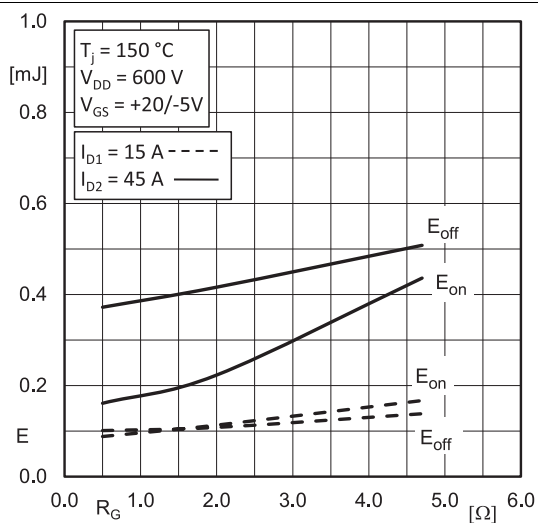

Fig. 5: Typ. turn-on /-off energy $E = f(R_G)$

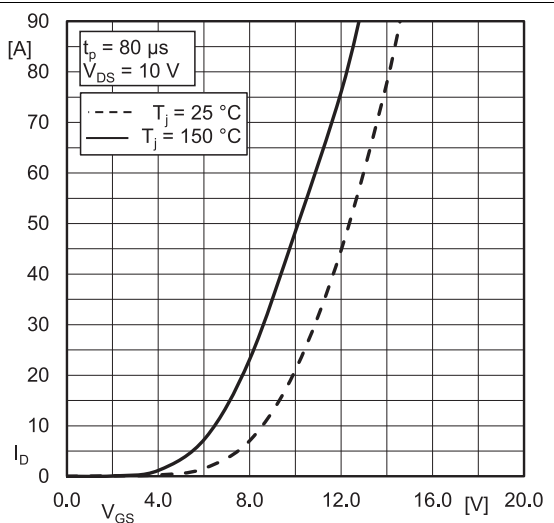

Fig. 6: Typ. MOSFET transfer characteristic

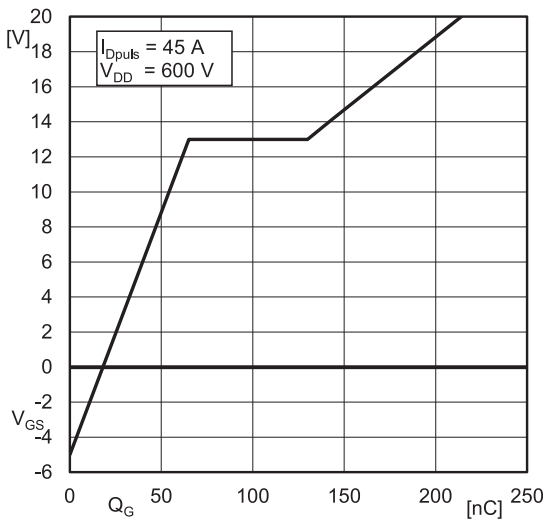

Fig. 7: Typ. MOSFET gate charge characteristic

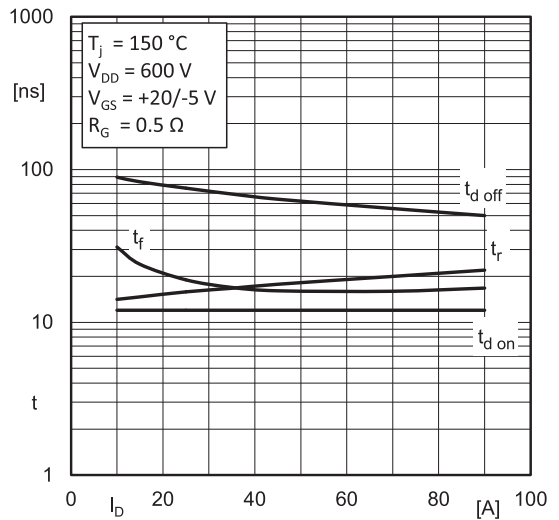

Fig. 8: Typ. switching times vs. I_D

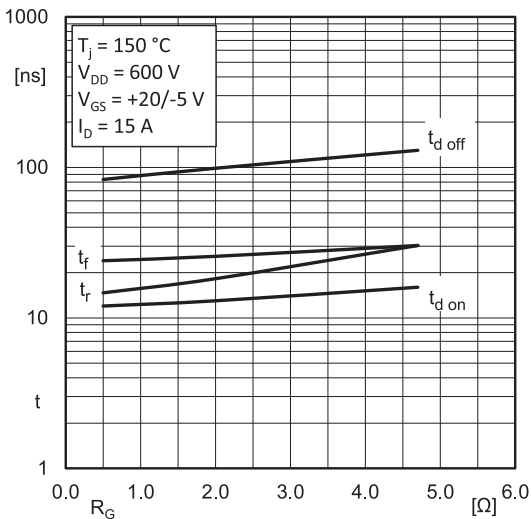

Fig. 9: Typ. switching times vs. gate resistor R_G at I_{D1}

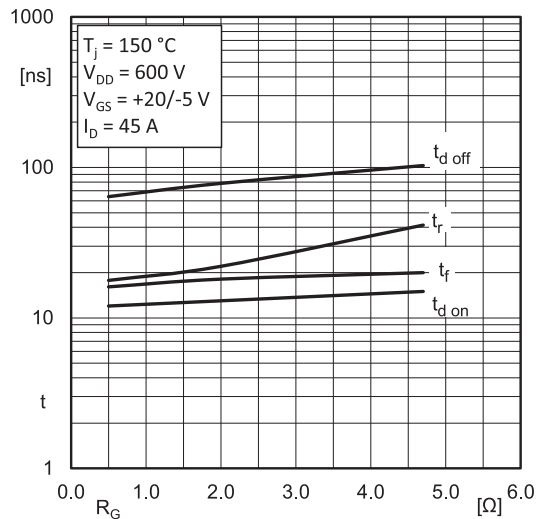

Fig. 10: Typ. switching times vs. gate resistor R_G at I_{D2}

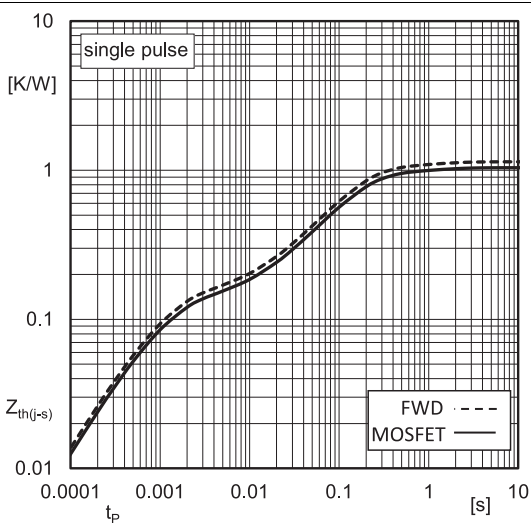

Fig. 11: Typ. transient thermal impedances

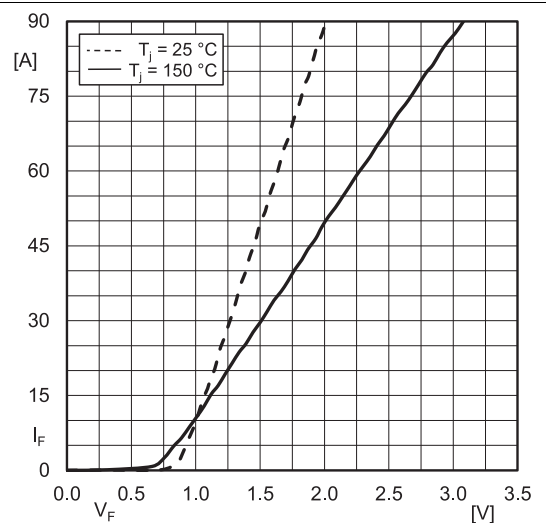
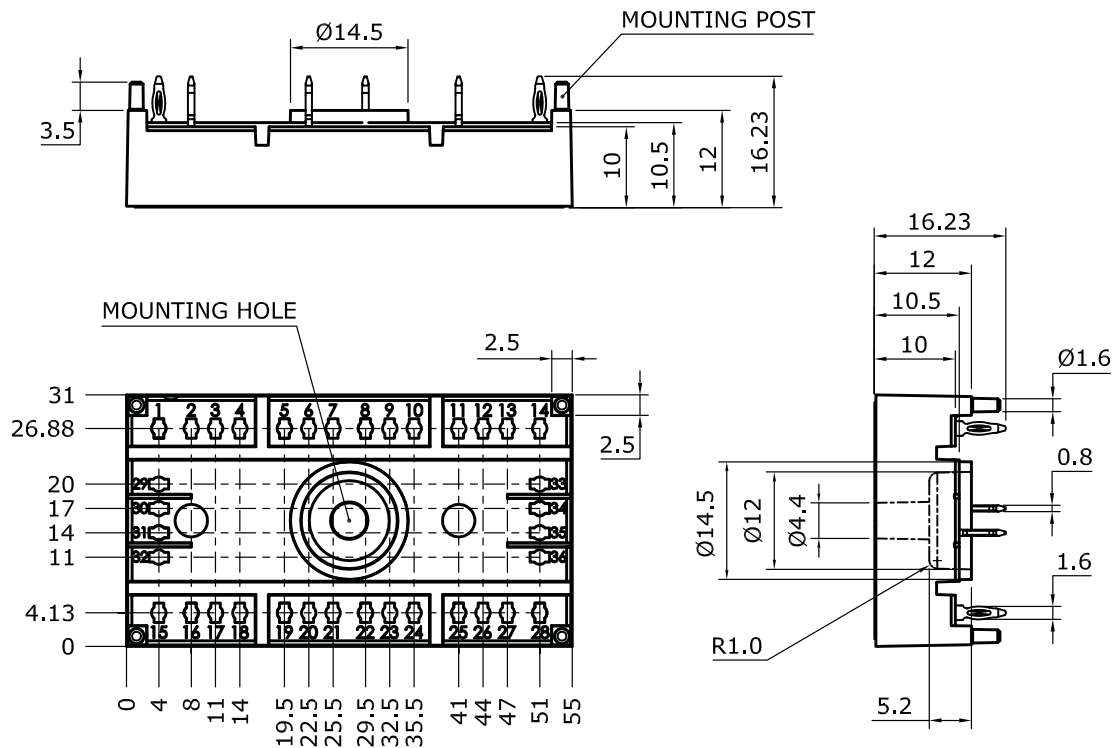

Fig. 12: Typ. FWD output characteristic, incl. R_{DD+ss}'

SK45MAHT12SCp

Dimensions: mm

Tolerance system: ISO 2768-m



Suggested drilled hole diameter for terminal pins in the circuit board:

- minimum: 1.575 mm
- typical: 1.6 mm
- maximum: 1.625 mm

Suggested hole diameter for the mounting post in the circuit board:

- 2 mm

These documents are SEMIKRON properties. SEMIKRON reserves all copyrights. All copying and transmitting of this information requires written permission. For the case of industrial property rights, SEMIKRON reserves all rights.

SEMITOP 3 Press-Fit

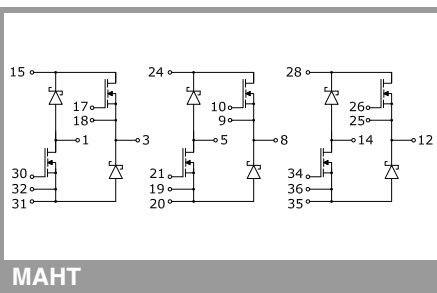

MAHT

This is an electrostatic discharge sensitive device (ESDS), international standard IEC 60747-1, chapter IX.

***IMPORTANT INFORMATION AND WARNINGS**

The specifications of SEMIKRON products may not be considered as guarantee or assurance of product characteristics ("Beschaffenheitsgarantie"). The specifications of SEMIKRON products describe only the usual characteristics of products to be expected in typical applications, which may still vary depending on the specific application. Therefore, products must be tested for the respective application in advance. Application adjustments may be necessary. The user of SEMIKRON products is responsible for the safety of their applications embedding SEMIKRON products and must take adequate safety measures to prevent the applications from causing a physical injury, fire or other problem if any of SEMIKRON products become faulty. The user is responsible to make sure that the application design is compliant with all applicable laws, regulations, norms and standards. Except as otherwise explicitly approved by SEMIKRON in a written document signed by authorized representatives of SEMIKRON, SEMIKRON products may not be used in any applications where a failure of the product or any consequences of the use thereof can reasonably be expected to result in personal injury. No representation or warranty is given and no liability is assumed with respect to the accuracy, completeness and/or use of any information herein, including without limitation, warranties of non-infringement of intellectual property rights of any third party. SEMIKRON does not assume any liability arising out of the applications or use of any product; neither does it convey any license under its patent rights, copyrights, trade secrets or other intellectual property rights, nor the rights of others. SEMIKRON makes no representation or warranty of non-infringement or alleged non-infringement of intellectual property rights of any third party which may arise from applications. Due to technical requirements our products may contain dangerous substances. For information on the types in question please contact the nearest SEMIKRON sales office. This document supersedes and replaces all information previously supplied and may be superseded by updates. SEMIKRON reserves the right to make changes.